

Service manual

Version: 2.00

Ident:

Series:

Part-Number: 1520_A/1620_A

This part can be ordered.



Chapter

baking chamber EBO68 400V 50Hz - V:
control EBO68 400V 50Hz - V:
door EBO64/68 400V 50Hz - V:
electric-installation digital/MAN EBO68 400V 50Hz - V:
electric-installation IS 500/600 EBO68 400V 50Hz - V:
frame EBO68 400V 50Hz - V:
installationroom EBO68 400V 50Hz - V:

Service manual baking chamber EBO68 400V 50Hz

Version:

Ident:

Series:

Part-Number:

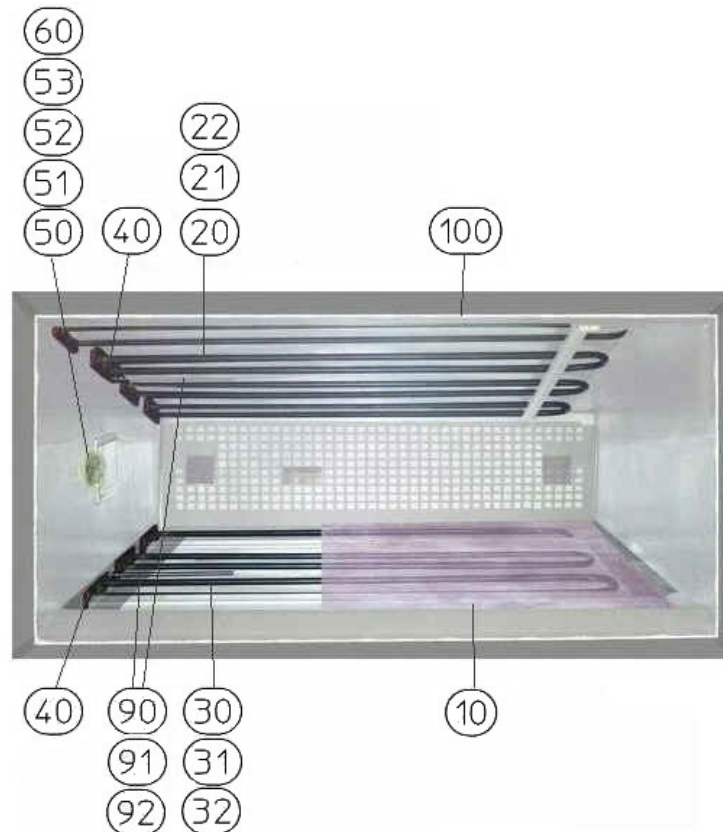

Chapter

- [010] - 105689 - stone baking plate EBO68; Attention replaced by 106056
- [010] - 106056 - stone baking plate EBO68
- [020/032] - 70530 - pipe heater 350W / 230V
- [021/030] - 70533 - pipe heater 450W / 230V
- [031] - 70531 - pipe heater 250W / 230V
- [040] - 105683 - seal for pipe heater
- [050] - 70179 - halogen lamp 12V / 50W
- [051] - 70510 - seal for bottom part of the lamp
- [052] - 70508 - Ebo frame for lamps-lower part
- [053] - 70509 - Ebo protective glass f. lamps-lower part
- [060] - 404835 - halogen lamp socket
- [060] - 70176 - socket 8-pole halogen lamp; Attention replaced by 404835
- [090] - 400263 - type K thermocouple
- [091] - 105679 - resistance thermometer PT500
- [091] - 9030-140-002 - resistance thermometer (SW13x125)
- [092] - 400266 - temperature probe
- [100] - 105686 - sealing rope; Attention replaced by 111296
- [100] - 111296 - sealing rope

Part: stone baking plate EBO68; Attention replaced by 106056**Part-Number: 105689**

When cleaning the stone plate do not use abrasive cleaner. Use only clear water and soft cloths.

**Part: stone baking plate EBO68****Part-Number: 106056**

When cleaning the stone plate do not use abrasive cleaner. Use only clear water and soft cloths.

Part: pipe heater 350W / 230V**Part-Number: 70530**

When replacing the pipe heater always to seal the heating pipe to be replaced.

**Part: pipe heater 450W / 230V****Part-Number: 70533**

When replacing the pipe heater always to seal the heating pipe to be replaced.

**Part: pipe heater 250W / 230V****Part-Number: 70531**

When replacing the pipe heater always to seal the heating pipe to be replaced.



Part: seal for pipe heater

Part-Number: 105683

When changing the pipe heating, always replace the seal of the pipe heating.



Part: halogen lamp 12V / 50W

Part-Number: 70179



Part: seal for bottom part of the lamp

Part-Number: 70510



Part: Ebo frame for lamps-lower part

Part-Number: 70508

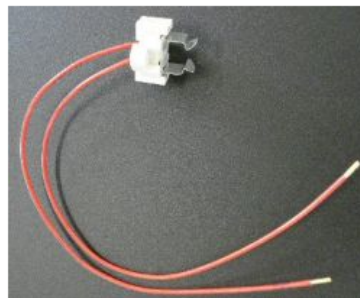

Part: Ebo protective glass f. lamps-lower part**Part-Number: 70509****Part: halogen lamp socket****Part-Number: 404835****Part: socket 8-pole halogen lamp; Attention replaced by 404835****Part-Number: 70176**

Part: type K thermocouple

Part-Number: 400263

The thermo element type K is used as an oven probe. The oven probe controls the oven temperature. The working range is between 30 - 250°C. Please note the polarity (+/-) when replacing the thermo elements. To prevent false measurements the probe must be inserted as far as it will go. Ensure that the oven probe feeds through the fan cover into the oven. The probe must not be in contact with the fan cover - false measurements or even deactivating the safety chain may be the result of coming in contact. If the probe is too short and does not fit into the oven, a probe extension is necessary. Read the shown concern to this article.



Part: resistance thermometer PT500

Part-Number: 105679

The temperature sensor PT 500 is used for devices with digital control. The electronics calculates the actual temperature out of the figures of the oven feeler.



Part: resistance thermometer (SW13x125)

Part-Number: 9030-140-002



Part: temperature probe

Part-Number: 400266

The Honeywell temperature sensor is used for devices with manual control (Honeywell). The oven feeler controls the actual temperature of the top or bottom heat.



Part: sealing rope; Attention replaced by 111296

Part-Number: 105686

The sealing cord has nearly no deterioration. Nevertheless it can easily be replaced if necessary. The sealing cord is put into the slot and bonded at the hems with heat resistant silicone.



Part: sealing rope

Part-Number: 111296

length at EBO 128/124 with 320 chamber = 2,90 m; length at EBO 128/124 with 355 chamber = 3,00 m; length at EBO 64/68 with 320 chamber = 1,65 m; length at EBO 64/68 with 355 chamber = 1,85 m

Service manual control EBO68 400V 50Hz

Version:

Ident:

Series:

Part-Number:



Chapter

control unit digital with Night start EBO68 400V 50Hz - V:
operating unit Honeywell EBO68 400V 50Hz - V:
operating unit IS 400 (Panel-Format) EBO68 400V 50Hz - V:
400502 - operating unit IS 500 EBO68 400V 50Hz - V:
101347 - operating unit IS 600 EBO68 400V 50Hz - V:

Service manual control unit digital with Night start EBO68 400V 50Hz

Version:

Ident:

Series:

Part-Number:

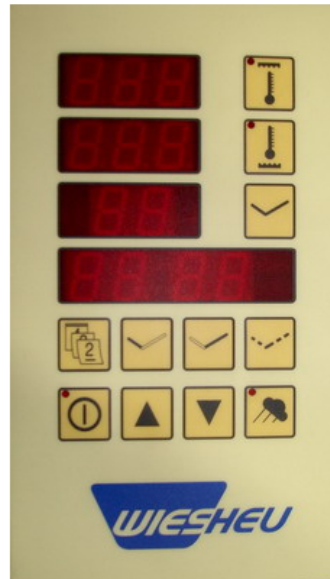

Chapter

400088 - operating foil digital
404846 - board digital without night launch (°C)
70178 - EBO control unit version 2.8

Part: operating foil digital

Part-Number: 400088

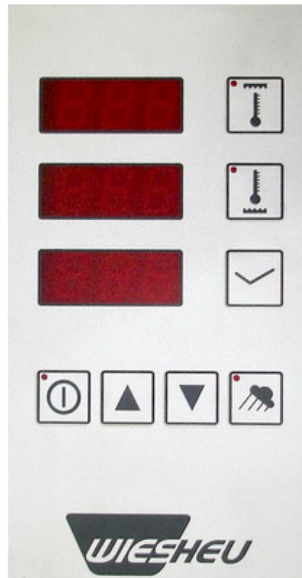

Part: board digital without night launch (°C)

Part-Number: 404846

This board is programmed under the item number 401295 in Fahrenheit.



Part: EBO control unit version 2.8

Part-Number: 70178

Service manual operating unit Honeywell EBO68 400V 50Hz

Version:

Ident:

Series:

Part-Number:

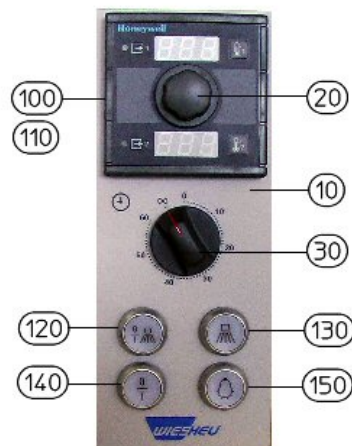

Chapter

- [010] - 400232 - operating foil Honeywell
- [020] - 9040-155-001 - dial knob Honeywell -regulator
- [030] - 36691 - knob timer
- [100] - 70046 - Honeywell control (max. 300°C)
- [110] - 70048 - Honeywell control (max. 400°C)
- [120] - 107499 - push button "boiler On/Off"
- [120] - 400777 - push button "baking chamber illuminating"; Attention replaced by 107499
- [130] - 400778 - illuminated push button "steam"
- [140] - 400774 - illuminated push button "On-/Off"
- [150] - 400776 - Push button "baking chamber illuminating"
- [xxx] - 105687 - time switch; Attention replaced by 110572
- [xxx] - 110572 - time switch WM 4-10
- [xxx] - 36058 - buzzer
- [xxx] - 400266 - temperature probe
- [xxx] - 400769 - illuminated notch
- [xxx] - 400770 - illuminated notch
- [xxx] - 400771 - illuminated key attachment adapter
- [xxx] - 400772 - illuminated key LED 230 V
- [xxx] - 400773 - illuminated key closing contact

Part: operating foil Honeywell

Part-Number: 400232

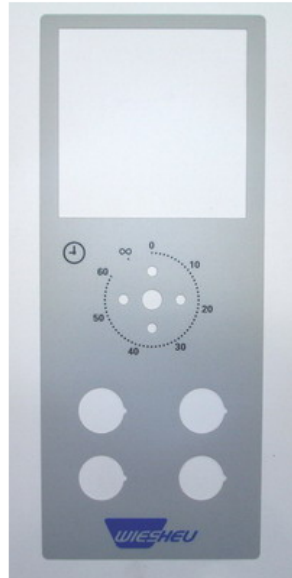

Part: dial knob Honeywell -regulator

Part-Number: 9040-155-001



Part: knob timer

Part-Number: 36691

Please note when ordering: Thermostat dial and timer dial have different connectors and are not compatible

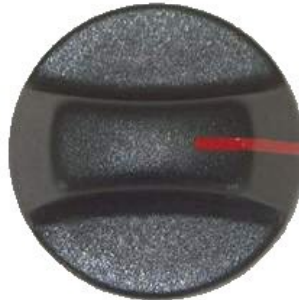

Part: Honeywell control (max. 300°C)

Part-Number: 70046



Part: Honeywell control (max. 400°C)

Part-Number: 70048

The double display up to 400°C is applied for devices with the "Pizza-Option".



Part: push button "boiler On/Off"**Part-Number: 107499**

Part: push button "baking chamber illuminating"; Attention replaced by 107499**Part-Number: 400777**

Part: illuminated push button "steam"**Part-Number: 400778**

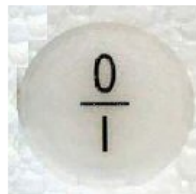
Part: illuminated push button "On-/Off"**Part-Number: 400774**

Part: Push button "baking chamber illuminating"

Part-Number: 400776



Part: time switch; Attention replaced by 110572

Part-Number: 105687

The timer switches the heater contact off. If a short time (1-20 mins) is set the timer is turned all the way to the end and then back to the required time.



Part: time switch WM 4-10

Part-Number: 110572

Part: buzzer

Part-Number: 36058

An acoustic signal is given at the end of the timer. (Buzzer 230 V)



Part: temperature probe

Part-Number: 400266

The Honeywell temperature sensor is used for devices with manual control (Honeywell). The oven feeler controls the actual temperature of the top or bottom heat.



Part: illuminated notch

Part-Number: 400769



Part: illuminated notch

Part-Number: 400770



Part: illuminated key attachment adapter

Part-Number: 400771



Part: illuminated key LED 230 V

Part-Number: 400772

LED only with manual version as well as IS400 version with water tank.



Part: illuminated key closing contact

Part-Number: 400773

By locking the switch the contactor tightens and the normally open contact closes the inductor circuit as long as the power is supplied.



Service manual operating unit IS 400 (Panel-Format) EBO68 400V 50Hz

Version:

Ident:

Series:

Part-Number:



Chapter

[010] - 105440 - operating foil IS400
[020] - 105725 - circuit board IS 400

Part: operating foil IS400

Part-Number: 105440

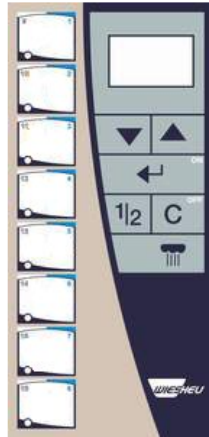

Part: circuit board IS 400

Part-Number: 105725



Service manual operating unit IS 500 EBO68 400V 50Hz

Version:

Ident:

Series:

Part-Number: 400502

This part can be ordered.

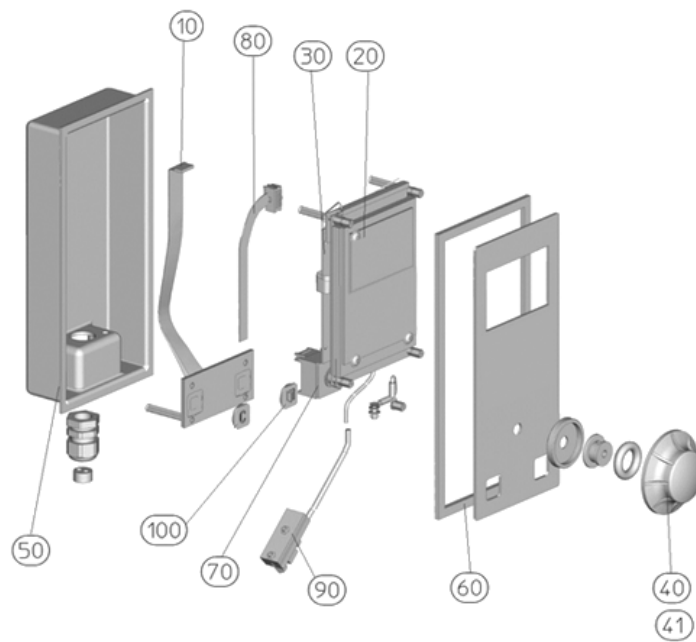

Chapter

- [010] - 101563 - key block
- [020] - 100804 - display IS500 with circuit board
- [030] - 105564 - electronic circuit board IS500
- [040] - 102685 - knob grey
- [050] - 102450 - frame IS
- [060] - 102449 - seal for frame IS
- [070] - 100591 - incremental encoder
- [080] - 104353 - ribbon cable for IS500
- [090] - 102806 - USB port with data wire

Part: key block

Part-Number: 101563

Ensure that the all contact to the connector is clean and free of grease. Its function can be tested with the Wiesheu PC-Tool/Test/Navigate.



Part: display IS500 with circuit board

Part-Number: 100804

This article has been replaced by Articles 104 771, but is not fully compatible. Please follow the spare part instruction "EH_196-0511-005 Display IS500"



Part: electronic circuit board IS500

Part-Number: 105564

When exchanging the electronic circuit board, please note that electrostatic charge and its components can cause major damage. Therefore please make sure that before coming in contact with the circuit board that the circuit board and its metal frame are completely discharged. Check the DIP - switch setting and the input resistance as in the enclosed document. If interference occurs when transferring data from the PC to the Control (dark display), use a flash cable and the programs flash writer to re-write the program. Read the operating-instructions for "Flash-Tool".

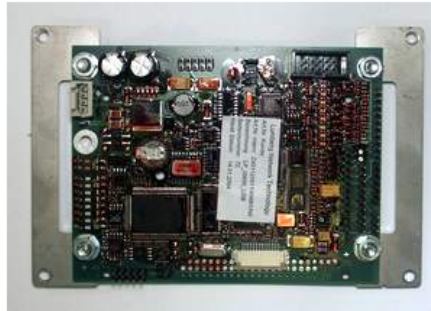

Part: knob grey

Part-Number: 102685

Depending on the version, the button "silver" or "grey" is used.



Part: frame IS

Part-Number: 102450

Check that all securing screws are present on the frame. In addition check the grounding to frame connection



Part: seal for frame IS

Part-Number: 102449

The seal must be correctly installed to avoid moisture admittance.



Part: incremental encoder

Part-Number: 100591

Check the incremental sensor using the function test in PC-Tool. To recall function test read the documents to the article.



Part: ribbon cable for IS500

Part-Number: 104353

The ribbon cable connects the circuit board IS 600 and the display. The ribbon cable has a plug on both sides. Ensure that the ribbon cable does not twist or kink.



Part: USB port with data wire

Part-Number: 102806

USB interface with USB connection "B". Data interface to PC.

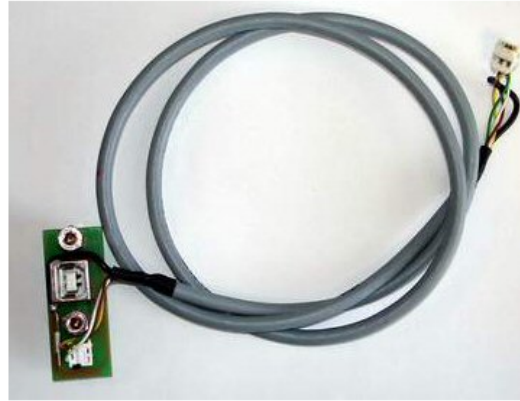

Service manual operating unit IS 600 EBO68 400V 50Hz

Version:

Ident:

Series:

Part-Number: 101347

This part can be ordered.

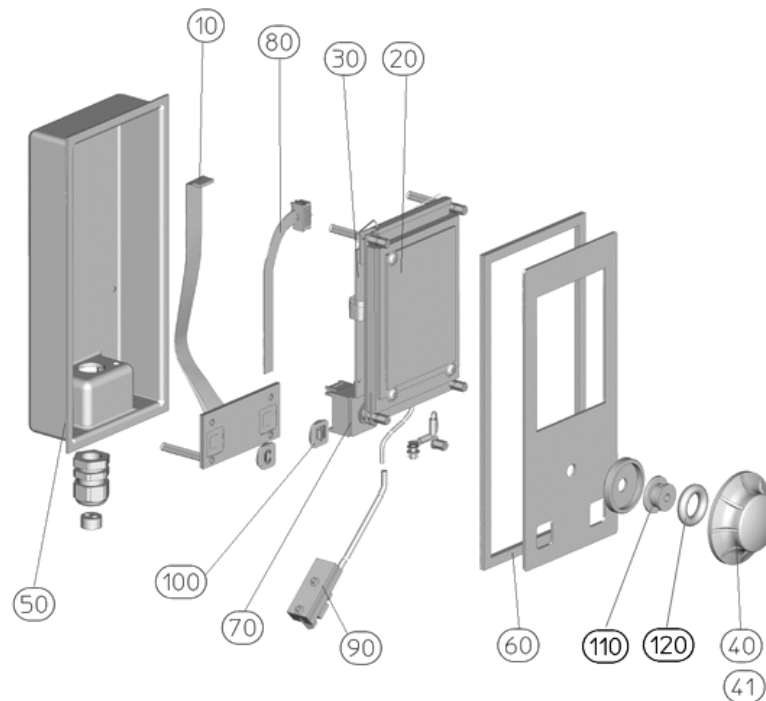

Chapter

- [010] - 101563 - key block
- [020] - 100617 - display IS600 with circuit board
- [030] - 101107 - electronic circuit board IS600
- [040] - 102685 - knob grey
- [041] - 101350 - knob silver
- [050] - 102450 - frame IS
- [060] - 102449 - seal for frame IS
- [070] - 100591 - incremental encoder
- [080] - 104354 - ribbon cable for IS600
- [090] - 102806 - USB port with data wire
- [100] - 105849 - key "C / door"
- [110] - 101434 - adapter_D54x22
- [120] - 101435 - O-ring_D16x7_NBR60

Part: key block

Part-Number: 101563

Ensure that the all contact to the connector is clean and free of grease. Its function can be tested with the Wiesheu PC-Tool/Test/Navigate.



Part: display IS600 with circuit board

Part-Number: 100617

Ensure that the all contact to the connector is clean and free of grease. Adjust the contrast of the screen to the surrounding area. Set the contrast by going to "Settings" - "Appliance Settings" - "Display" - "Contrast".



Part: electronic circuit board IS600

Part-Number: 101107

When exchanging the electronic circuit board, please note that electrostatic charge and its components can cause major damage. Therefore, please make sure that before coming in contact with the circuit board that the circuit board and its metal frame are completely discharged. Check the DIP - switch setting and the input resistance as in the enclosed document. If interference occurs when transferring data from the PC to the Control (dark display), use a flash cable and the programs flash writer to re-write the program. Read the instructions about part documents.



Part: knob grey

Part-Number: 102685

Depending on the version, the button "silver" or "grey" is used.



Part: knob silver

Part-Number: 101350

Depending on the version, the button "silver" or "grey" is used.



Part: frame IS

Part-Number: 102450

Check that all securing screws are present on the frame. In addition check the grounding to frame connection



Part: seal for frame IS

Part-Number: 102449

The seal must be correctly installed to avoid moisture admittance.

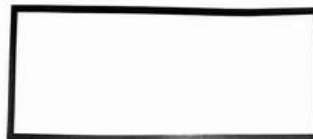

Part: incremental encoder

Part-Number: 100591

Check the incremental sensor using the function test in PC-Tool. To recall function test read the documents to the article.



Part: ribbon cable for IS600

Part-Number: 104354

The ribbon cable connects the circuit board IS 600 and the display. The ribbon cable has a plug on both sides. Ensure that the ribbon cable does not twist or kink.



Part: USB port with data wire

Part-Number: 102806

USB interface with USB connection "B". Data interface to PC.



Part: key "C / door"

Part-Number: 105849

The keys "C/door" are to be acquired seperately.

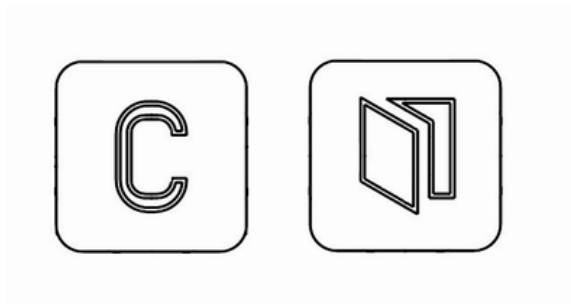

Part: adapter_D54x22

Part-Number: 101434



Part: O-ring_D16x7_NBR60

Part-Number: 101435



Service manual door EBO64/68 400V 50Hz

Version:

Ident:

Series:

Part-Number:

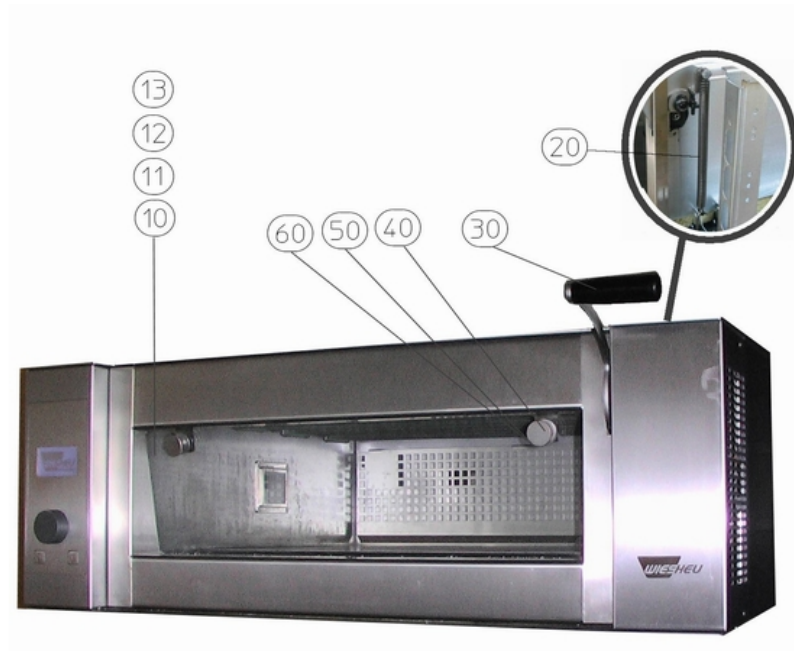

Chapter

E109342 - service kit EBO door flap 64/68 320 - V:

- [010] - 402659 - glass pane EBO64/68 (chamber 355mm, Pizza-Version)
- [011] - 402660 - glass pane EBO64/68 (chamber 230mm, Pizza-Version)
- [012] - 70063 - glass pane EBO64/68 (chamber 355mm)
- [013] - 70064 - glass pane EBO64/68 (chamber 320mm)
- [023] - 403222 - silicone pad
- [030] - 70148 - door handle black
- [040] - 70210 - knurled screw DIN 635
- [050] - 33878 - glass plate holder silicone
- [060] - 404235 - washer DIN 9021 A2

Part: glass pane EBO64/68 (chamber 355mm, Pizza-Version)

Part-Number: 402659

The glass pane is fixed by two knurled head screws. For cleaning dismount the pane and use only clear water and mild detergent. When installing the pane, make sure that the silicon holder for te glass is connected directly and the washer is between the knurled srew and this holder.

Part: glass pane EBO64/68 (chamber 230mm, Pizza-Version)

Part-Number: 402660

The glass pane is fixed by two knurled head screws. For cleaning dismount the pane and use only clear water and mild detergent. When installing the pane, make sure that the silicon holder for te glass is connected directly and the washer is between the knurled srew and this holder.

Part: glass pane EBO64/68 (chamber 355mm)

Part-Number: 70063

The glass pane is fixed by two knurled head screws. For cleaning dismount the pane and use only clear water and mild detergent. When installing the pane, make sure that the silicon holder for te glass is connected directly and the washer is between the knurled srew and this holder.

Part: glass pane EBO64/68 (chamber 320mm)

Part-Number: 70064

The glass pane is fixed by two knurled head screws. For cleaning dismount the pane and use only clear water and mild detergent. When installing the pane, make sure that the silicon holder for te glass is connected directly and the washer is between the knurled srew and this holder.

Part: silicone pad

Part-Number: 403222



Part: door handle black

Part-Number: 70148

The door hinge is also available in "silver" or "gold" colour for the "nostalgia" version



Part: knurled screw DIN 635

Part-Number: 70210

The glass pane is fixed by the knurled head screw.



Part: glass plate holder silicone

Part-Number: 33878



Part: washer DIN 9021 A2

Part-Number: 404235



Service manual

service kit EBO door flap 64/68 320

Version:

Ident:

Series:

Part-Number: E109342

This part can be ordered.

Chapter

- [010] - 403969 - shaft for window, square bar
- [020] - 111327 - bearing shaft for window, left assembled
- [030] - 109163 - bearing shaft for window EBO
- [040] - 109322 - door lever welded EBO
- [050] - 400817 - hook short
- [060] - 400765 - tension spring
- [070] - 70210 - knurled screw DIN 635
- [080] - 404235 - washer DIN 9021 A2
- [090] - 33878 - glass plate holder silicone
- [100] - 111416 - spring ring M10
- [110] - 42210 - washer
- [120] - 42694 - screw M5x12
- [130] - 42674 - screw
- [140] - 42034 - nut
- [150] - 42048 - spring ring 5,2
- [160] - 42641 - nut M8
- [170] - 35013 - screw M8x16
- [180] - 42073 - nut

Part: shaft for window, square bar

Part-Number: 403969

Part: bearing shaft for window, left assembled

Part-Number: 111327

Part: bearing shaft for window EBO

Part-Number: 109163

Part: door lever welded EBO

Part-Number: 109322

**Part: hook short**

Part-Number: 400817

**Part: tension spring**

Part-Number: 400765



Part: knurled screw DIN 635**Part-Number: 70210**

The glass pane is fixed by the knurled head screw.

**Part: washer DIN 9021 A2****Part-Number: 404235****Part: glass plate holder silicone****Part-Number: 33878****Part: spring ring M10****Part-Number: 111416****Part: washer****Part-Number: 42210**

Part: screw M5x12

Part-Number: 42694

**Part: screw**

Part-Number: 42674

**Part: nut**

Part-Number: 42034

**Part: spring ring 5,2**

Part-Number: 42048

Part: nut M8

Part-Number: 42641

**Part: screw M8x16**

Part-Number: 35013



Part: nut

Part-Number: 42073



Service manual electric-installation digital/MAN EBO68 400V 50Hz

Version:

Ident:

Series:

Part-Number:

Chapter

- [010] - 36058 - buzzer
- [011] - 401523 - loudspeaker
- [020] - 38086 - knob thermostat
- [021] - 70355 - safety limit switch
- [030] - 70511 - transformer
- [040] - 33884 - relay main switch
- [050] - 80131 - time relay EZ12AW-230V
- [060] - 70508 - Ebo frame for lamps-lower part
- [070] - 70509 - Ebo protective glass f. lamps-lower part

Part: buzzer

Part-Number: 36058

An acoustic signal is given at the end of the timer. (Buzzer 230 V)



Part: loudspeaker

Part-Number: 401523

The loud speaker signal serves as an acoustic signal. For example notification is given for "temperature reached", "end of program". It is controlled by the circuit board.



Part: knop thermostat

Part-Number: 38086



Part: safety limit switch

Part-Number: 70355

The temperature safety limit switch (STB) is the overheating protection for the baking chamber. It is activated at a temperature of 360°C. The heater connector switches off and the appliance quits working. Once the oven cools down the STB can be manually reset. The measurement occurs from the fluid in the capillary tube. Ensure when placing the capillary tube that it does not kink. The result is false readings or interruption. Insulate the capillary tube on the critical spots (e.g. circuit board) with silicone hose article number 40074.

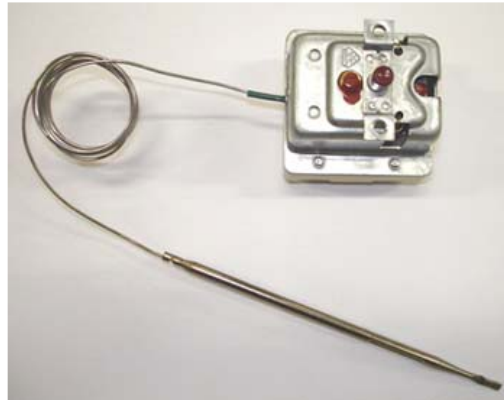

Part: transformer

Part-Number: 70511



Part: relay main switch

Part-Number: 33884

The contactor switches the heater on/off.



Part: time relay EZ12AW-230V

Part-Number: 80131

Part: Ebo frame for lamps-lower part

Part-Number: 70508



Part: Ebo protective glass f. lamps-lower part

Part-Number: 70509



Service manual electric-installation IS 500/600 EBO68 400V 50Hz

Version:

Ident:

Series:

Part-Number:



Chapter

- [010] - 101106 - power board
- [020] - 401523 - loudspeaker
- [050] - 70509 - Ebo protective glass f. lamps-lower part
- [060] - 70508 - Ebo frame for lamps-lower part
- [070] - 33884 - relay main switch
- [080] - 70511 - transformer
- [090] - 70355 - safety limit switch

Part: power board

Part-Number: 101106

Disconnect power before beginning work. This article is fully prepared for servicing purposes. Please read the appropriate "Article Documents". When replacing the electronic circuit board, electrostatic can damage the circuit board and its components. Ensure before handling the electrical circuit board that a grounded metal frame discharges the electrostatic. The electrical circuit board is available as a service circuit board in a complete version under the Order Number 101106 and can also be used in other appliance models. On the circuit board you will find 3 fuses. F2 output L1 (4A tr); F3 output N (4A tr); F4 output transformer 24, 12, 5 V (1,5A tr). The circuit board has Eprom with each current software update and an 8 pole Dip- switch (configurations switch). Attention must be given to which switch the Dip- switch is actively switched. The various switch settings can be found in the assembly instruction.



Part: loudspeaker

Part-Number: 401523

The loud speaker signal serves as an acoustic signal. For example notification is given for "temperature reached", "end of program". It is controlled by the circuit board.



Part: Ebo protective glass f. lamps-lower part

Part-Number: 70509



Part: Ebo frame for lamps-lower part

Part-Number: 70508



Part: relay main switch

Part-Number: 33884

The contactor switches the heater on/off.



Part: transformer

Part-Number: 70511



Part: safety limit switch

Part-Number: 70355

The temperature safety limit switch (STB) is the overheating protection for the baking chamber. It is activated at a temperature of 360°C. The heater connector switches off and the appliance quits working. Once the oven cools down the STB can be manually reset. The measurement occurs from the fluid in the capillary tube. Ensure when placing the capillary tube that it does not kink. The result is false readings or interruption. Insulate the capillary tube on the critical spots (e..g. circuit board) with silicone hose article number 40074.

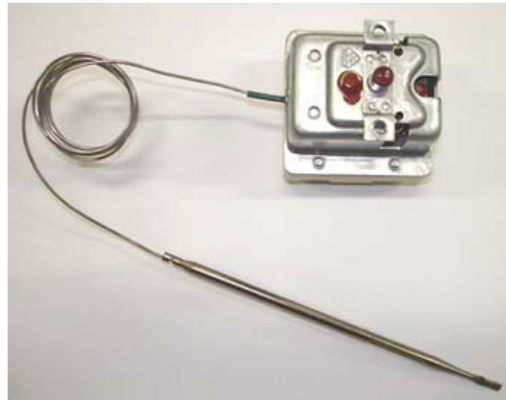

Service manual frame EBO68 400V 50Hz

Version:

Ident:

Series:

Part-Number:

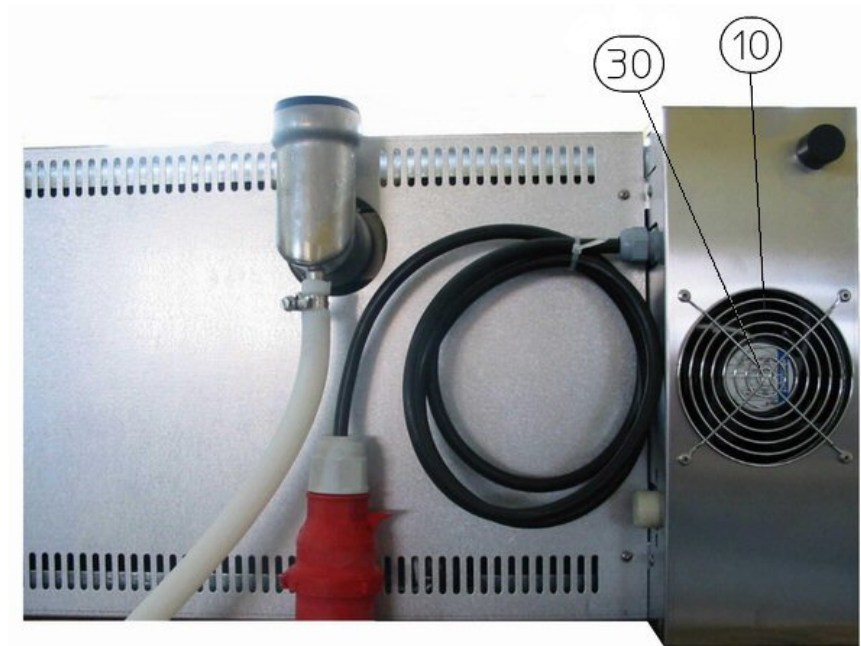

Chapter

[010] - 402662 - axial blower 19W heat resistance until 75°C

[020] - 402169 - cap EBO cover light

[030] - 33973 - axial fan cover

Part: axial blower 19W heat resistance until 75°C

Part-Number: 402662

Axial fan to cool the electronic components. Heat resistant up to 75°C, marked with the letter "Z". The service uses as after-market equipment the axial fan, item no. 402661, heat resistant up to 85°C marked with the letter "N".



Part: cap EBO cover light

Part-Number: 402169

Part: axial fan cover

Part-Number: 33973

To avoid injury the axial fan cover must be installed correctly.



Service manual installation room EBO68 400V 50Hz

Version:

Ident:

Series:

Part-Number:

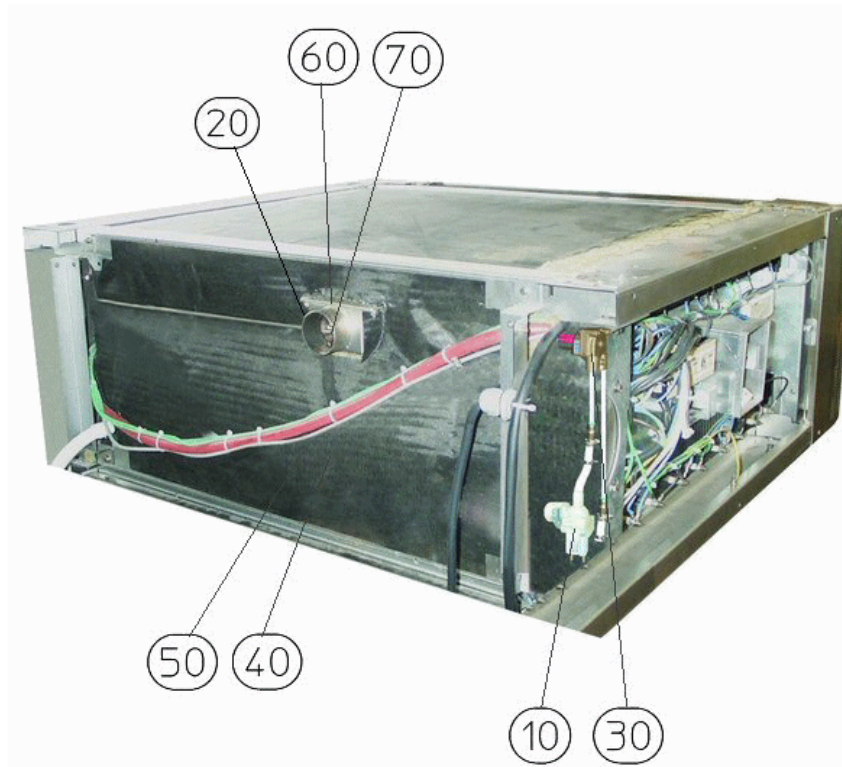

Chapter

E111528 - steam generator EBO68 400V 50Hz - V:

- [010] - 111324 - solenoid valve with straight 1 / 4 "thread
- [010] - 403754 - solenoid valve (flow restrictor) Attention replaced by 111324
- [020] - 107049 -
- [030] - 36126 - water flow detector flow meter FH20
- [050] - 03617 - seal for steam generator
- [060] - 105684 - seal for air case
- [070] - 03619 -
- [070] - 105685 - seal for air flap; Attention replaced by 03619

Part: solenoid valve with straight 1 / 4 "thread

Part-Number: 111324

It is necessary to clean the dirt sieve of the solenoid valve regularly. Particles in the water line will stick to the sieve and interrupt the water flow. Please note the maximum water pressure and other warnings from the data sheets regarding the water connection. The solenoid valve works with a flow pressure of 150 - 600 kPa. You can test the solenoid valve function in the PC - Tool - Test. Attention the test is a continued test and this function is not protected from overload.

Part: solenoid valve (flow restrictor) Attention replaced by 111324

Part-Number: 403754

It is necessary to clean the dirt sieve of the solenoid valve regularly. Particles in the water line will stick to the sieve and interrupt the water flow. Please note the maximum water pressure and other warnings from the data sheets regarding the water connection. The solenoid valve works with a flow pressure of 150 - 600 kPa. You can test the solenoid valve function in the PC - Tool - Test. Attention the test is a continued test and this function is not protected from overload.



Part:

Part-Number: 107049

Part: water flow detector flow meter FH20

Part-Number: 36126

The flow meter measures the water flow amount. When installing, pay attention to the polarity +/- of the impulse meter (Hall sensor).



Part: seal for steam generator

Part-Number: 03617

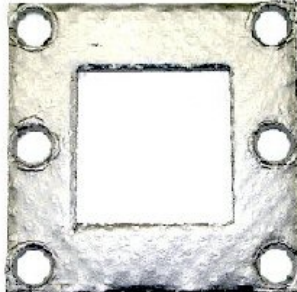

Part: seal for air case

Part-Number: 105684



Part:

Part-Number: 03619

Part: seal for air flap; Attention replaced by 03619

Part-Number: 105685



Service manual steam generator EBO68 400V 50Hz

Version:

Ident:

Series:

Part-Number: E111528

This part can be ordered.

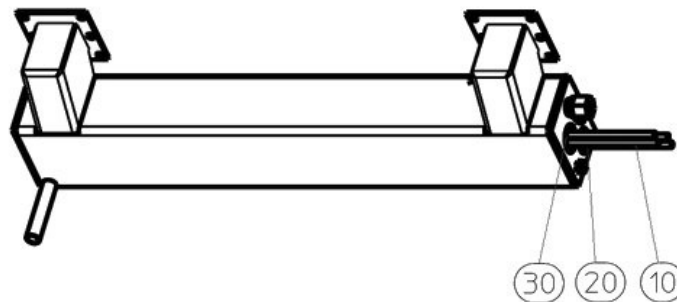

Chapter

- 109084 - boiler flange
- 109277 - between isolation boiler
- 109402 - isolation on the boiler EBO 64/68
- 109403 - isolation under the boiler EBO 64/68
- 403116 - cutting ring D12
- 404919 - nut for boiler connection
- 70800 - seal copper
- 402933 - screwing
- [010] - 402885 - heater 750W / 230V
- [020] - 400263 - type K thermocouple
- [030] - 34352 - thermostat
- [040] - 402914 - steam pipe connection EBO 64/68 (from 2007 - up to date)
- [040] - 78057 - Steam pipe connection EBO 64 (in the year 2000)
- [040] - E108045 - steam generator with flange EBO 64/68 (from 1997 - 1999)

Part: boiler flange

Part-Number: 109084

Part: betwwen isolation boiler

Part-Number: 109277

Part: isolation on the boiler EBO 64/68

Part-Number: 109402

Part: isolation under the boiler EBO 64/68

Part-Number: 109403

Part: cutting ring D12

Part-Number: 403116

**Part: nut for boiler connection**

Part-Number: 404919

Part: seal copper

Part-Number: 70800

The copper seal ring seals the steaming system. Place correctly when installing.



Part: screwing

Part-Number: 402933



Part: heater 750W / 230V

Part-Number: 402885

When replacing the pipe heater always to seal the heating pipe to be replaced.



Part: type K thermocouple

Part-Number: 400263

The thermo element type K is used as an oven probe. The oven probe controls the oven temperature. The working range is between 30 - 250°C. Please note the polarity (+/-) when replacing the thermo elements. To prevent false measurements the probe must be inserted as far as it will go. Ensure that the oven probe feeds through the fan cover into the oven. The probe must not be in contact with the fan cover - false measurements or even deactivating the safety chain may be the result of coming in contact. If the probe is too short and does not fit into the oven, a probe extension is necessary. Read the shown concern to this article.



Part: thermostat

Part-Number: 34352

The thermostat measures the temperature. The measurement is performed on the fluid-filled capillary tube. When routing the capillary tube that this is not broken, because otherwise the measurements are distorted or interrupted. Insulate the capillary tube at critical points (for example circuit board) with silicone tubing article 40074



Part: steam pipe connection EBO 64/68 (from 2007 - up to date)

Part-Number: 402914

The steam pipe initiates the water in the steam generator.



Part: Steam pipe connection EBO 64 (in the year 2000)

Part-Number: 78057



Part: steam generator with flange EBO 64/68 (from 1997 - 1999)

Part-Number: E108045

Urheberrecht:

Das Urheberrecht an diesem Servicehandbuch verbleibt bei der WIESHEU GmbH. Dieses Servicehandbuch ist nur für autorisierte Servicepartner und dessen Personal bestimmt. Sie enthält Vorschriften und Hinweise, die weder vollständig noch teilweise vervielfältigt, verbreitet oder anderweitig mitgeteilt werden dürfen.

Alle Darstellungen, Zeichnungen, Bilder Texte und Angaben sind urheberrechtlich geschützt. Sie unterliegen den gewerblichen Schutzrechten.

Zu diesem Servicehandbuch:

Alle Abbildungen in diesem Dokument sollen die Verständlichkeit unterstützen. Die Abbildungen sind nicht maßstabsgerecht. Teilweise sind dem Originalprodukt ähnelnde Abbildungen dargestellt, die geringfügig abweichen können.

Achtung!

Vermeiden Sie Fehlfunktionen oder Beschädigungen durch falsche Ersatzteile. Wir empfehlen die ausschließliche Verwendung von WIESHEU-Original-Ersatzteilen.

Wiesheu GmbH
Daimlerstrasse 10
DE-71563 Affalterbach
Telefon: +49 (0)7144 / 3 03-0
Fax: +49 (0)7144 / 3 03-11
Service-Telefon: 0800-WIESHEU
E-Mail: info@wiesheu.de
www.wiesheu.de

Stand: 19.04.2012